



THE JEWELLER'S BOX COMPANY

€ Information Pack 2021



78 - 80 Troutbeck, Albany Street, London NW1 4EJ, England

Tel: 020 7391 9991 Fax: 020 7391 9993

Email: info@thejewellersboxcompany.com Website: www.thejewellersboxcompany.com

Bespoke & Custom Products

In order to make our working with you on your own special products simpler and more efficient we have developed some guidelines by which we need to work. We hope that these will be clear to you from the start so that errors are minimised and time is not lost, both in sampling and production. Below are some pointers to help you prepare to develop your own products more easily.

How To Develop Your Own Products With Us

We are able to make a very wide range of shapes, sizes, colours and finishes of leather boxes and other products for you. We have developed a 'standard' range of packaging, which, from our experience covers most jewellers' requirements. These are listed together with their prices, and other details including colours and linings, on a separate sheet called Standard Packaging. Many boxes can be used for several items of jewellery simply by interchanging the pads used inside the boxes. All our boxes are fully lined with pullout inserts, except for some necklace box options. Often customers stock several styles of pad per box size in order to maintain full flexibility.

All products have to be sampled first and the samples have to be fully approved before production can commence. Any alterations that need to be made to the first samples will require further samples to be made. If the alterations needed are our fault, we will re-sample free of charge. If, however, you require alterations to the original designs agreed, a charge will normally be made.

In order to make your samples we need **clear black on white artwork** of the logos or designs you wish to have incorporated onto your boxes. **If we need to alter your artwork there will normally be an artwork charge. We will inform you of this charge before we proceed.**

1. First you will need to decide which shape of boxes appeals to you most: square/rectangle, rounded square, cushion shaped oval or round. **We do not supply outer cardboard boxes for any of our products for production reasons.**

2. Next the colour of leather must be chosen, our standard colours are black, brown, blackberry, burgundy, dark green, dark red, red, dark purple, navy blue. Colours that include a 10% surcharge are fuchsia, royal blue, aqua, emerald green and purple. Colours that have a 15% surcharge are tan, natural, orange and pantone matched colours (where possible). This covers the extra wastage of leather incurred. **Please also note that some colours are sensitive to light and may change over time. We will advise you of this when discussing your requirements.**

3. Then you will need to decide on the colour of the lining of your boxes. Please note that very light fabrics will be surcharged at 10% of the cost of both the box and pads because a great deal of extra care is needed to produce these items.

4. We have to work out which sizes and styles of boxes suit your jewellery. Our standard sizes cover most items but we know that many designers make very large or unusual shaped pieces, which we are also able to accommodate at a modest extra charge. Remember that the interchangeable pads make many of our boxes extremely flexible and you can normally manage with 4-6 boxes sizes only, using different pads, to accommodate all the items you sell.

5. The size and placement of your logo comes next. We will be able to assist you with this. We are specialised in blind embossed work (raised embossing). Our standard prices include one blind embossed logo per item. Extra logos and other forms of embossing will be quoted to you as necessary. **Each item needs its own specifically sized metal block for each surface embossed.**

6. We offer display pads and trays to our packaging customers only. There is also a small range of items suitable as gifts for your special customers, which we can make to suit your own colours etc. These also need to be sampled before production.

We are willing to sample half of a set of samples in a one colour way and the other in a second colour way, so you can see the 'real thing' before you make your final decision. This applies to both leather and lining fabrics. It is at the sampling stage that all alterations need to be made and options explored.

Once the final samples have been approved and your order processed, no further alterations can be made.

Timing

Sampling normally takes 4-6 weeks from receipt of your artwork in our office. In periods of maximum production, our suppliers sometimes require even longer but we will inform you if this is the case. Please note we will communicate with you when we have received your artwork with a full list of what you have requested, for your signature of confirmation. In this way we both understand what is being sampled on your behalf and the costs involved, (costs may be approximate in the case of special sizes etc).

Production of your subsequent order normally takes 6-8 weeks from receipt of your deposit payment (See Terms & Conditions – Payment). Timing can depend on the quantity required and also the time of the year you are ordering. We can give you a verbal idea of timing but the confirmed date of dispatch to us by our suppliers will be given to us only a few days after receipt of the confirmed order by them and this will be communicated to you.

If there are specific deadlines involved, please let us know before we begin sampling so that we can be sure to fulfil them or inform you at once if it is not possible for us to meet them.

Care of leather

Our products are hand made from vegetable tanned sheep or goats leather which makes the colours more vulnerable to light. We will make you aware of the colours which darken or change over time when we are discussing your requirements with you.

Leather is a living material which is not happy in moist or very dry atmospheres. Please be sure to unpack your boxes out of their protective cellophane wraps and store them in a cool dry place out of direct light. Air conditioning can sometimes cause condensation to collect on the boxes and this will damage them.

Alternating heat and cold can bring out a whitish bloom which is the polish seeping from the surface. Normally this can be removed by using a soft dry cloth to polish the affected surfaces.

The glazed finish of our boxes is such that if it is scratched polish will not repair it. On the other hand it is very soft to the touch and ages very gracefully. Cleaning only requires a soft cloth to polish it.

Samples

All products have to be sampled first and fully approved by the customer before production can commence. We charge for all samples including their related block charges, our sample administration charge and the cost of sending them to you for your approval. The sample invoice will be sent to you with your samples for immediate payment.

Should you not go forward with an order for all the samples made for you in good faith you will still be liable to pay for them including the second set of samples we make for reference, and their ancillary charges. **Everything is clearly set out for you in writing for approval and signature before we make any samples.**

There is a **Sample Administration Charge (SAC)** of **€300 per set of samples**. (this is reduced to €165 for a single sample). This contributes towards the very real administrative costs we incur in preparing your samples for you. The **block charges and SAC are both one-off charges.**

Our prices, block charges (B/C) and minimum order quantity (M/Q) per item are listed on our Standard Packaging and all other product sheets. These are for the standard products and depend on the colours chosen. Items not on these lists will be quoted separately.

Please note that unlike most embossing, the method we use is different and so each item has to have its own block to cover the **whole** surface of the item (Effectively we stamp the whole item except for the logo or design). Thus a smallish pouch requires quite a large block to cover the whole piece of leather used.

If we make an error we will correct it free of charge. If you change your mind or require alterations to the original sample requested, the new sample will be charged again, including a new block if needed.

Ordering

Orders can only be accepted on fully approved samples

You will receive a fully detailed list of the items we have sampled for you, with prices and minimum's listed clearly. If you are happy with the samples you can order immediately, otherwise we will need to resample, (which we will do as quickly as possible). Your order will be prepared and returned to you for signature of confirmation. At this point your deposit invoice will be raised and sent to you (see payment below). Orders can only be placed on receipt of payment of this deposit and, in the case of first orders, the sample invoice.

Quality Control

Every item is checked in London before it is sent out. As all products are hand made we do have some items which reach us in less than perfect condition. This means that our deliveries are not always 100% of the goods actually ordered. In case you need a minimum number of an item for a special event for example, you will need to increase the order by 10% [5% on orders over 300 pieces per item]. In this case you are obliged to take all good product, which may be up to 110% of the original order.

Payment

We require 50% payment on account for all orders before production can commence. We will send you a deposit invoice for 50% of the total cost of the whole order you have placed. As soon as we receive payment your order will be placed with our suppliers and the expected delivery date will be confirmed. The second 50% and shipping costs, if relevant, will be invoiced when the goods are shipped to you. At this time any shortfall/extra supply of products through quality control or other problems will be taken into account so that on the payment of the second invoice you will only be paying for the exact amount of product you have received. The second payment is due 30 days from date of invoice.

Packing

We normally pack items according to size in cellophane outers in order to protect the products. Should you require the items to be individually packed in cellophane, for gift items for example, please let us know on your order. We do not supply cardboard outer boxes with our products, as they are very expensive to make in small quantities.

Carriage

We will ask you where and how you would like your goods to be sent. When your goods are ready to ship we will fax or email you the final invoice and the packing list in order to notify you that the goods are being dispatched. The details of the carrier and consignment note will be included at this time.

Any missing or damaged goods received must be notified to us in writing within 14 days of receipt. Any errors will, of course, be corrected at our cost.

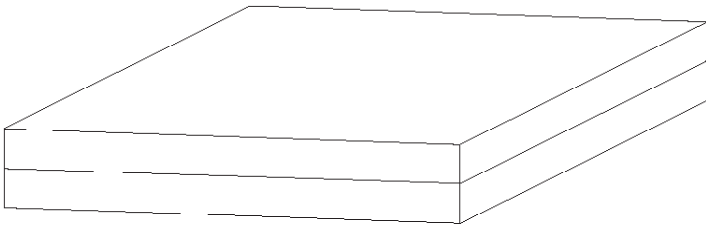

Necklace box

Size: 18x18x3cm, 1.5/1.5cm split
 Price: € 41.55
 Block Charge: € 55.00, Min Qty: 10

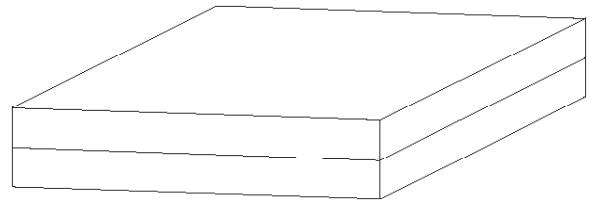

Necklace box medium

Size: 14.5x14.5x3cm, 1.5/1.5cm split
 Price: € 30.10
 Block Charge: € 55.00, Min Qty: 10

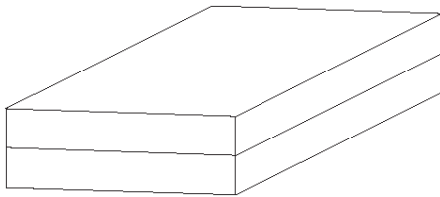

Necklet box

Size: 9x13.5x3cm, 1.5/1.5cm split (**Portrait**)
 Size: 13.5x9x3cm, 1.5/1.5cm split (**Landscape**)
 Price: € 19.70
 Block Charge: € 43.00, Min Qty: 25

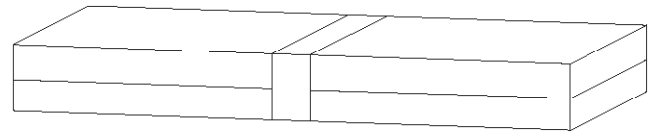

Bracelet box

Size: 22x5x2.5cm, 1.25/1.25cm split
 Price: € 19.25
 Block Charge: € 43.00, Min Qty: 25

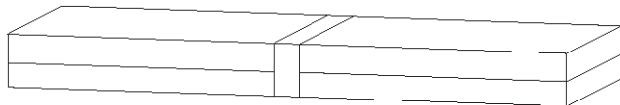

Bracelet box narrow

Size: 22x3.5x2cm, 1/1cm split
 Price: € 16.15
 Block Charge: € 43.00, Min Qty: 25

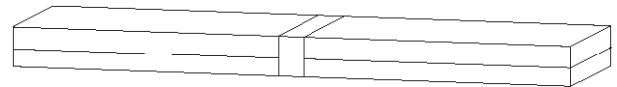

Bracelet box slimline

Size: 22x2x1.5cm, 0.75/0.75cm split
 Price: € 13.90
 Block Charge: € 31.00 Min Qty: 25

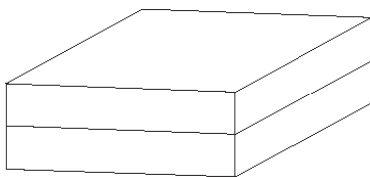

Universal box 9

Size: 9x9x4cm, 1.5/2.5cm split
 Price: € 14.35
 Block Charge: € 43.00, Min Qty: 25

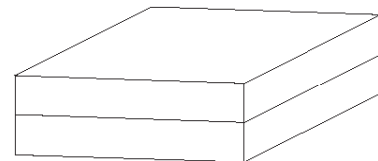

Bangle box

Size: 9x9x3cm, 1.5/1.5cm split
 Price: € 13.40
 Block Charge: € 43.00, Min Qty: 25

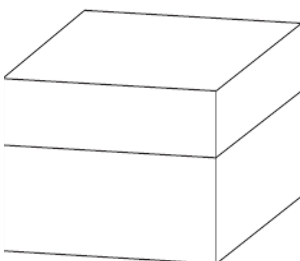

Cuff Box

Size: 9x6x7cm, 2.5/4.5cm split
 Price: € 19.90
 Block Charge: € 31.00, Min Qty: 25

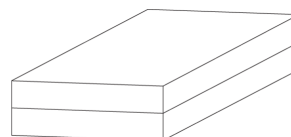

Earring box

Size: 7x9x3cm, 1.5/1.5cm split
 Price: € 13.60
 Block Charge: € 31.00, Min Qty: 25

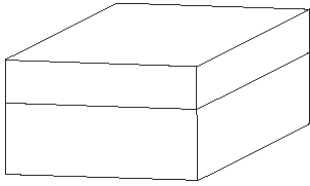

Universal box 7

Size: 7x7x4cm, 1.5/2.5cm split
 Price: € 12.30
 Block Charge: € 31.00, Min Qty: 25

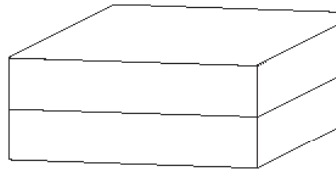

Cufflink/Ring box

Size: 7.5x5.5x3cm, 1.5cm/1.5cm split
 Price: €10.95
 Block Charge: € 31.00, Min Qty: 25

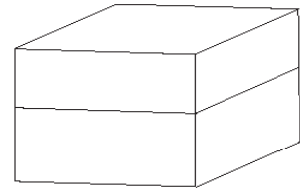

Ring box 5.5

Size: 5.5x5.5x4cm, 1.5cm/2.5cm split
 Price: € 9.75
 Block Charge: € 31.00

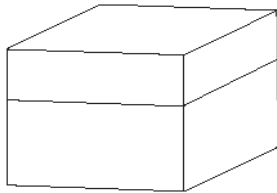

Ring box 5

Size: 5x5x4cm, 1.5cm/2.5cm split
 Price: € 9.15
 Block Charge: € 31.00, Min Qty: 50

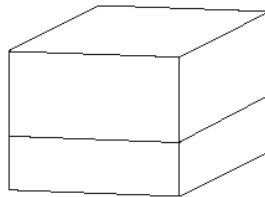

Upside down ring box

Size: 5x5x4cm, 2.5/1.5cm split
 Price: € 9.90
 Block Charge: € 31.00, Min Qty: 50

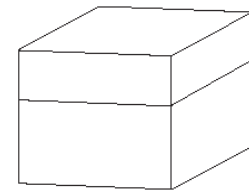

Ring box 4

Size: 4x4x4cm, 1.5cm/2.5cm split
 Price: € 8.60
 Block Charge: € 31.00, Min Qty: 50

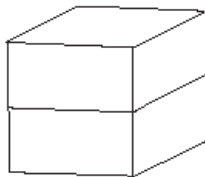

Smartie box

Size: 3.5x3.5x3.5cm, 1.5cm/1.5cm split
 Price: £6.80
 Block Charge: \$ 35.00, Min Qty: 50

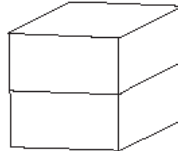

Smartie box

Size: 3x3x3cm, 1.5cm/1.5cm split
 Price: € 7.60
 Block Charge: € 31.00, Min Qty: 50

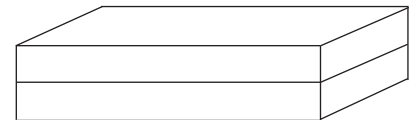

Wedding ring box

Size: 7x3.5x2cm, 1cm/1cm split
 Price: € 9.10
 Block Charge: € 31.00, Min Qty: 25



Large pouch

Size: 15x8cm
 Price: € 16.45
 Block Charge: € 55.00 Min Qty: 10

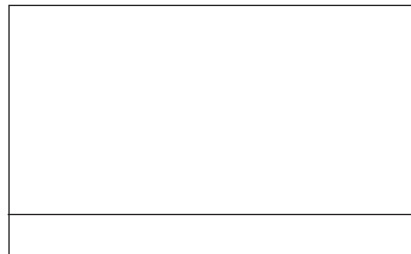

Medium pouch

Size: 10x7cm
 Price: € 10.50
 Block Charge: € 43.00, Min Qty: 25

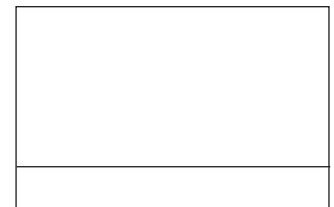

Small pouch

Size: 7x5cm
 Price: € 7.60
 Block Charge: € 31.00, Min Qty: 50

We offer our Standard Boxes in square, rounded square, cushion shaped and round with a wide range of pull out inserts to accommodate the jewellery. All boxes are fitted with foam in the lid and are fully lined. They are priced as empty. The box price also includes the blocking of a logo or design on one surface of each box. The blocking of further logos or designs will attract an extra charge of 30p per block used. Block charges are incurred per block made, (see prices listed below). **Standard colours are: Black, Brown, Blackberry, Burgundy, Dark Red, Red, Dark Purple, Navy Blue and Dark Green. Please note that the following colours attract a surcharge of 10% on box prices only: Fuchsia, Royal Blue, Aqua, Emerald Green and Bright Purple. Natural leather, Tan, Orange and Pantone colour matches can be supplied at a surcharge of 15%.** Also light coloured linings attract a surcharge of 10% on both box and pad prices. Our all-over logo design charge is €100 plus €20 per item that it is sized for.

Price	Code	Item (Several of the inserts available are listed under each box size)	Block Charge	Minimum Quantity
41.55	NB	NECKLACE BOX	55.00	10
3.95	A2	Fixed 2 hook pad		5
4.95	C2	Fixed 2 strap pad		5
6.55	D	Fixed ring		5
1.40	E2	Foam in base		5
30.10	NBM	NECKLACE BOX MEDIUM	55.00	10
2.90	A2	Fixed 2 hook pad		5
3.75	C2	Fixed 2 strap pad		5
5.40	D	Fixed ring		5
1.15	E2	Foam in base		5
26.50	NBS	NECKLACE BOX SMALL	43.00	25
2.90	A2	Fixed 2 hook pad		10
2.90	C2	Fixed 2 strap pad		10
1.35	E2	Foam in base		10
19.70	NKB	NECKLET BOX	43.00	25
4.05/4.60	E1/E3	Hard foam pad / Hard Foam Pad with fabric strap		10
19.25	BRB	BRACELET BOX w/ leather ring	43.00	25
1.35	E2	Foam in base		10
2.30	G2	Fixed 2 Elastic pad		10
2.40	H2	Fixed 2 hook pad		10
16.15	BBN	BRACELET BOX NARROW w/ leather ring	43.00	25
1.15	E2	Foam in base		10
2.00	G2	Fixed 2 Elastic pad		10
1.95	H2	Fixed 2 hook pad		10
13.90	BBSL	BRACELET BOX SLIMLINE w/2 mini hooks and leather ring	31.00	25
14.35	UB9	SQUARE UNIVERSAL BOX 9	43.00	25
13.40	BB	BANGLE BOX	43.00	25
3.50/1.05/3.85	E1/ E2/ E3	Hard foam pad / Foam in base / Hard foam pad with strap		10
3.75	N	Pillow [only for 4cm high box]		10
12.30	UB7	SQUARE UNIVERSAL BOX 7	31.00	25
2.75/ 3.15/ 0.85	E1 / E2 / E3	Hard foam pad / Foam in base / Hard Foam with strap		10
3.10	N	Pillow [only for 4cm high box]		10
5.05	Q	Stud earring pad		10
3.25/3.60	S2 / S4	Elastic cufflink pad - 2/4 elastics [only for 4cm high box]		10
4.70	W1	Single ring insert [only for a 4cm high box]		10
6.05	Y	Double ring insert [only for a 4cm high box]		10

19.90	CB	CUFF BOX		25
4.15	O	Oval Wedge pillow to fit 6cm side		10
5.75	Y	Double ring insert (for hoops)		10
13.60	EB	EARRING BOX	31.00	25
2.85/3.15	E1/E2	Hard foam pad / Hard Foam Pad with strap		10
4.45	W1	Single ring insert		10
10.95	CR	CUFFLINK/RING BOX	31.00	25
3.80	Q	Stud earring pad		10
4.00	W1	Single ring insert		10
4.85	Y	Double ring insert		10
11.05	RB6	RING BOX	31.00	25
4.00	Q	Stud earring pad		10
3.90/3.00	W1 / W2	Single ring insert / Fixed single ring insert		10
4.80	W3	Split single ring insert		10
5.40	Y	Double ring insert		10
1.80	Z	Stacking ring roll		10
9.75	RB5.5	RING BOX	31.00	50
4.00	Q	Stud earring pad		20
3.70/3.00	W1 / W2	Single ring insert / Fixed single ring insert		20
3.80	W3	Split single ring insert		20
4.65	Y	Double ring insert		20
1.65	Z	Stacking ring roll		20
9.15	RB5	RING BOX	31.00	50
9.90	USDRB5	UPSIDE DOWN RING BOX	31.00	50
3.75	Q	Stud earring pad		20
3.15/2.50	W1/W2	Double roll / Fixed double roll		20
3.85	W3	Split double roll, 1.8cm high (2 parts)		20
4.25	Y	Triple roll		20
1.70	Z	Single ring roll		20
8.60	RB4	RING BOX	31.00	50
3.00/ 2.35	W1/ W2	Single ring insert / Fixed single insert		20
9.50	SB3.5	SMARTIE BOX L w/ fixed single ring insert	31.00	50
8.70	SB3	SMARTIE BOX w/ fixed single ring insert	31.00	50
9.10	WR	WEDDING RING BOX	31.00	25
16.45	LP	LARGE POUCH	55.00	10
10.50	MP	MEDIUM POUCH	43.00	25
7.60	SP	SMALL POUCH	31.00	50

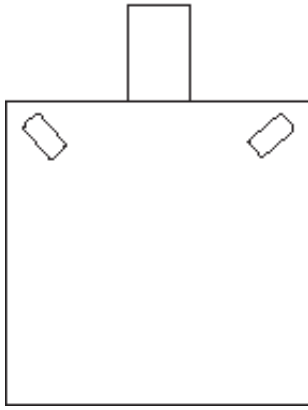

A1 2 hook pad with tab
A2 Fixed 2 hook pad

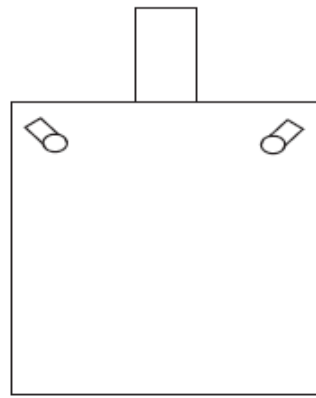

C1 2 stud strap pad with tab
C2 Fixed 2 stud strap pad

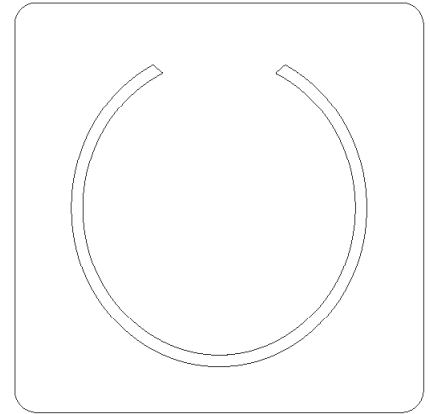

D Fixed ring pad

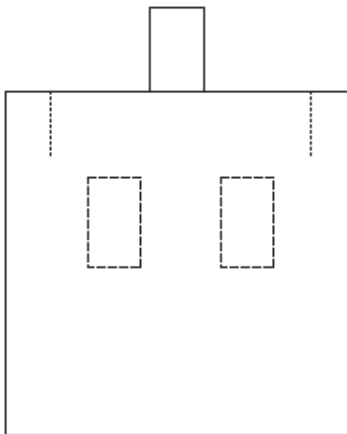

E1 Hard foam pad with 2 hidden slits cuts & tab

E2 Foam in base

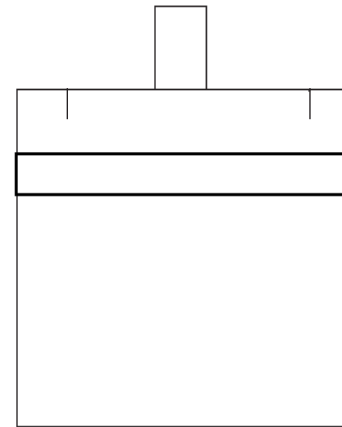

Hard foam pad with
E3 fabric strap & tab

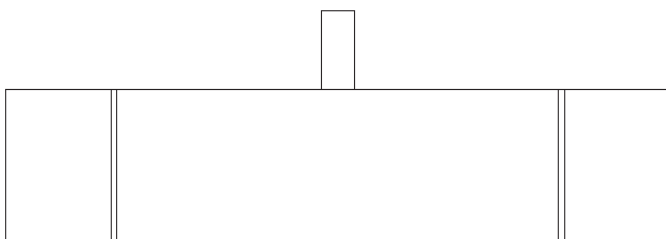

G1 Elastic pad with tab
G2 Fixed elastic pad with tab

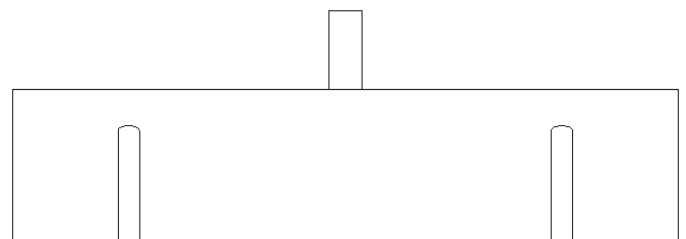

H1 2 hook pad with tab
H2 Fixed 2 hook pad with tab

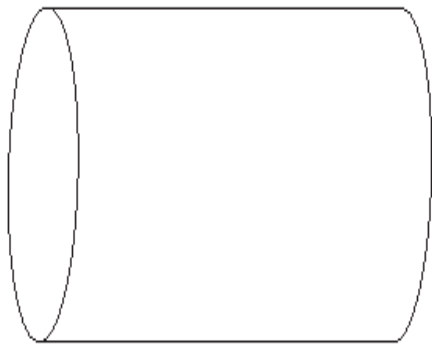

M Oval bangle pillow

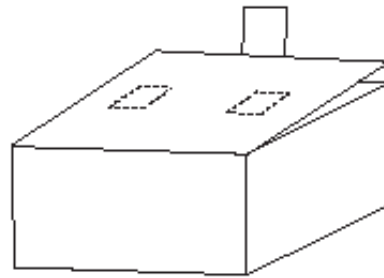

Q Stud earring pad with 2 hidden cuts & tab with platform

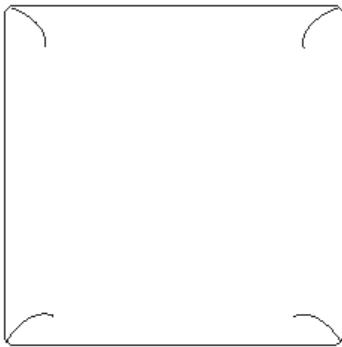

N Soft pillow

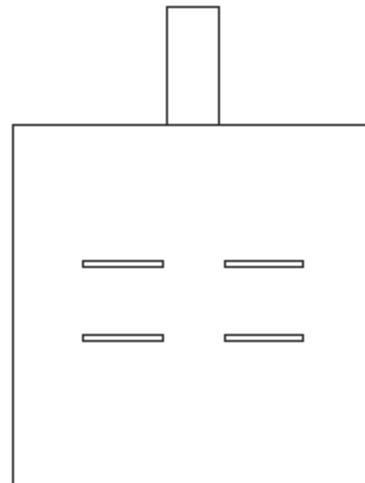

S4 Cufflink pad with 4 elastics & tab

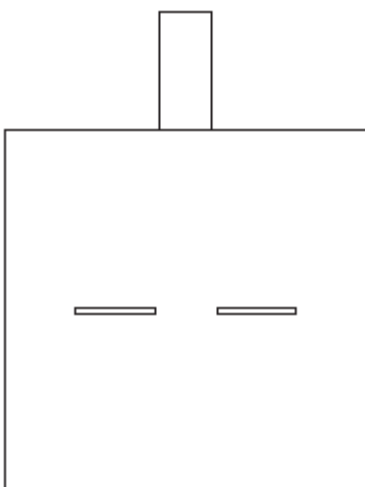

S2 Cufflink pad with 2 elastics & tab

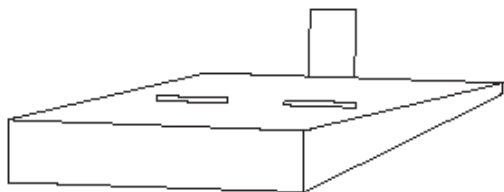

T Angled cufflink pad with 2 elastics & tab

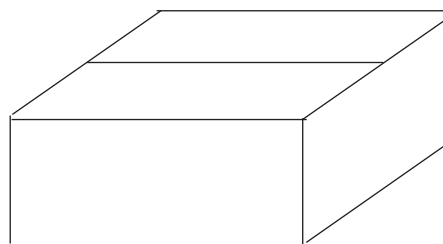

W1 Single ring insert
W2 Fixed single ring insert

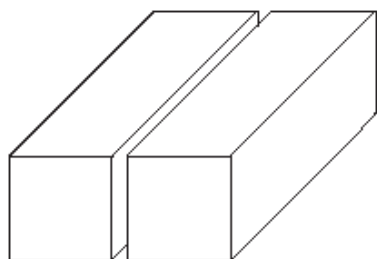

W3 Split single ring insert

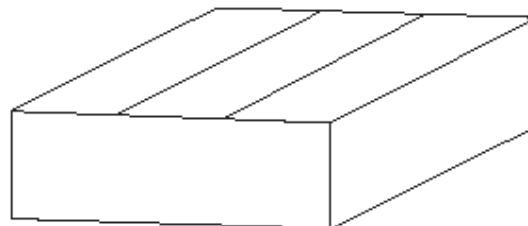

Y Double ring insert



Z Stacking ring roll
(18mm diameter)

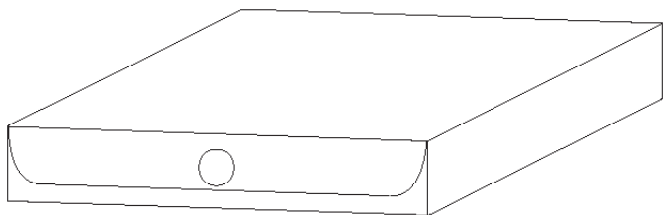

Large Pearl box
 Size: 14.5x14.5x2.5cm
 Price: € 35.00
 Block Charge: € 55.00, Min Qty: 10

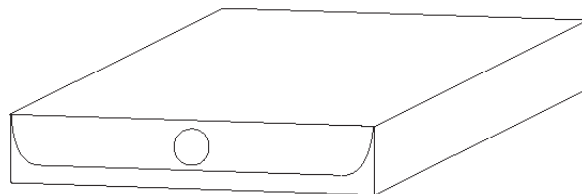

Medium Pearl box
 Size: 12.5x12.5x2.3cm
 Price: € 29.20
 Block Charge: € 43.00, Min Qty: 10

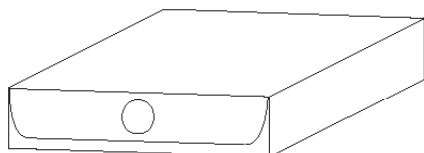

Small Pearl box
 Size: 9x9x2cm
 Price: € 16.95
 Block Charge: € 43.00, Min Qty: 25

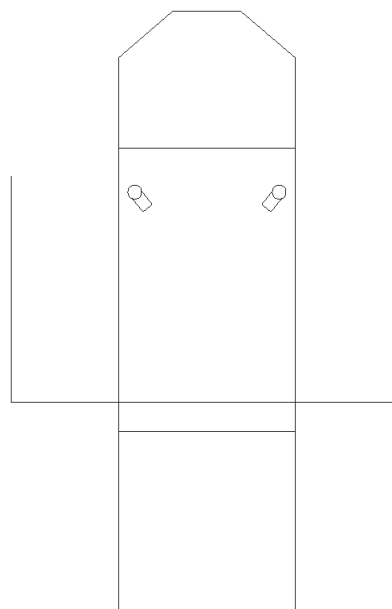

Pearl folder
 Size: 21x15.5cm (closed)
 Price: € 36.70
 Block Charge: € 77.15, Min Qty: 5

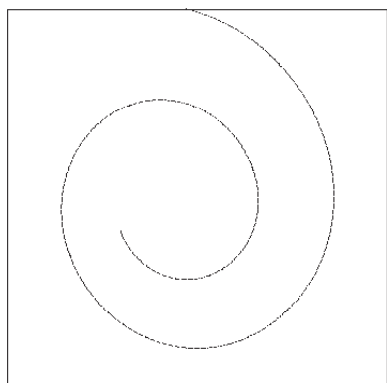

View inside Pearl Coil boxes

Display boards and trays have black velvet covered bases and padding under both leather and fabric. The price includes two embossed logos per board.

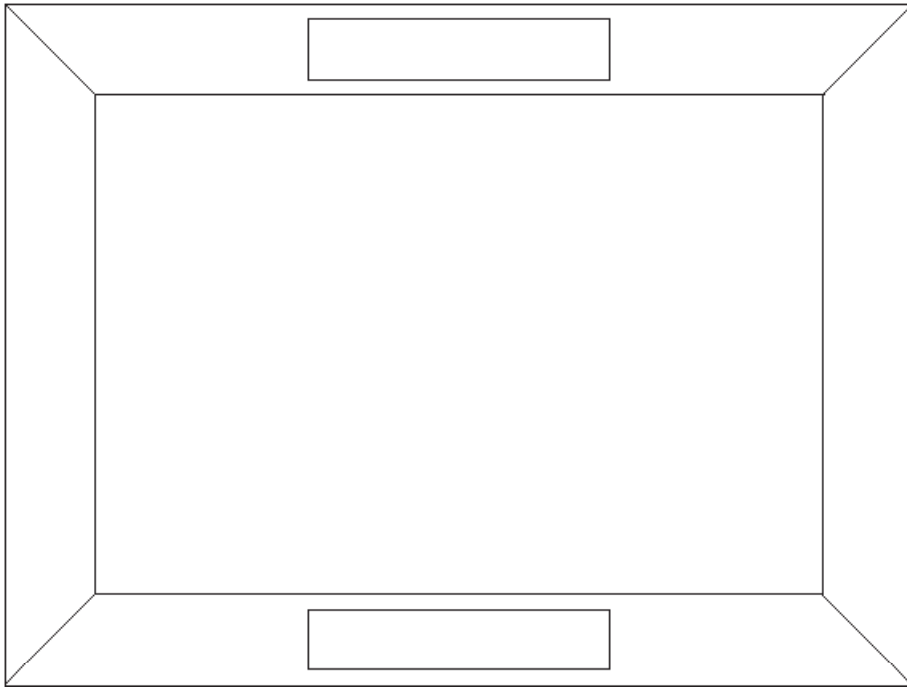

Display board rectangular

Size: 40x30cm with 4cm leather border

Price: € 43.80

Block Charge: € 55.00, Min Qty: 10

Display board square

Size: 30x30cm with 3cm leather border

Price: € 36.70

Block Charge: € 43.00, Min Qty: 10

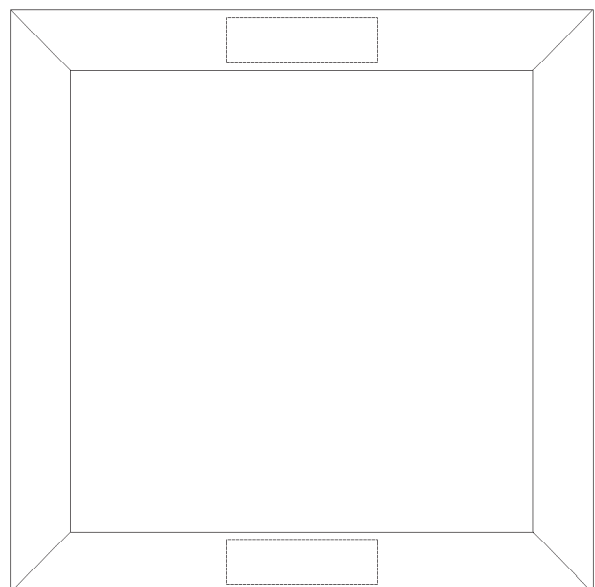

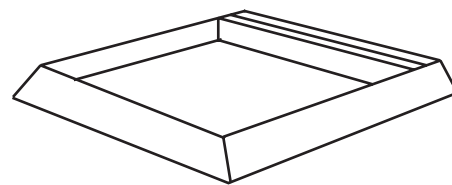
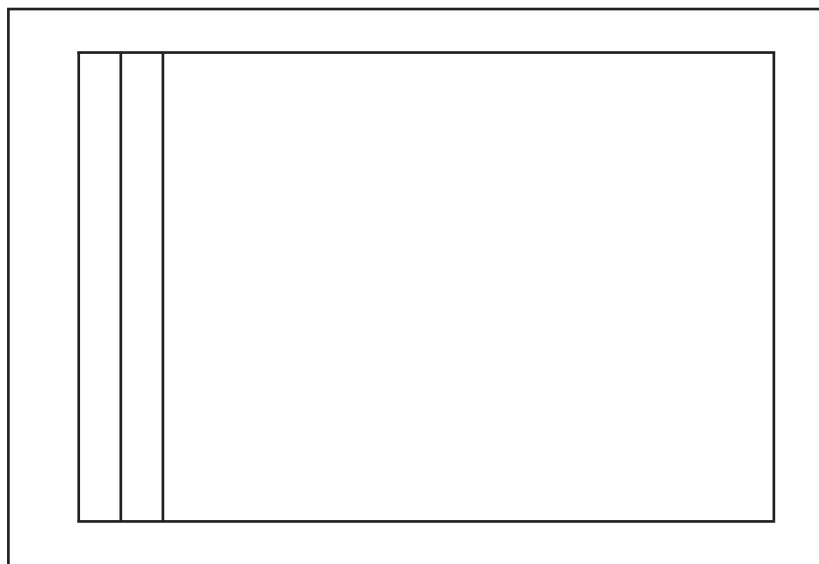

Side view

Large Rectangular Display tray with fixed ring holder

Size: 36x26cm with 3cm slanted leather border

Price: € 51.65

Block Charge: € 43.00, Min Qty: 10

Square Display tray with fixed ring holder

Size: 30x30cm with 3cm slanted leather border

Price: € 49.25

Block Charge: € 43.00, Min Qty: 10

Size: 25x25cm with 2.5cm slanted leather border

Price: € 42.70

Block Charge: € 43.00, Min Qty: 10

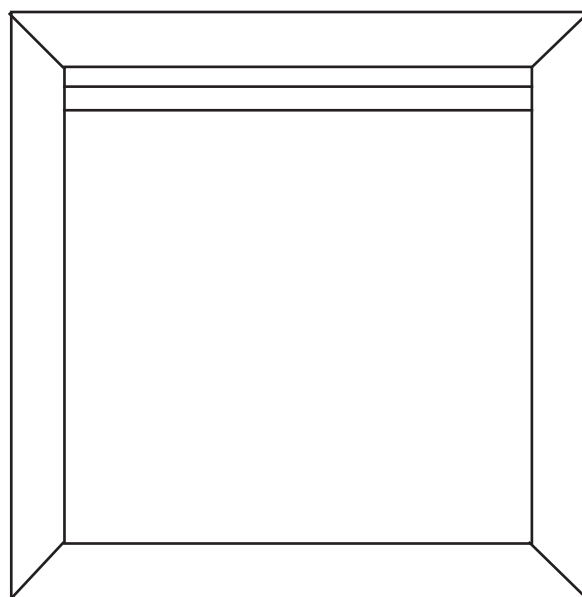

Rectangular Display tray with fixed ring holder

Size: 30x15cm with 2.5cm slanted leather border

Price: € 26.10

Block Charge: € 43.00, Min Qty: 10

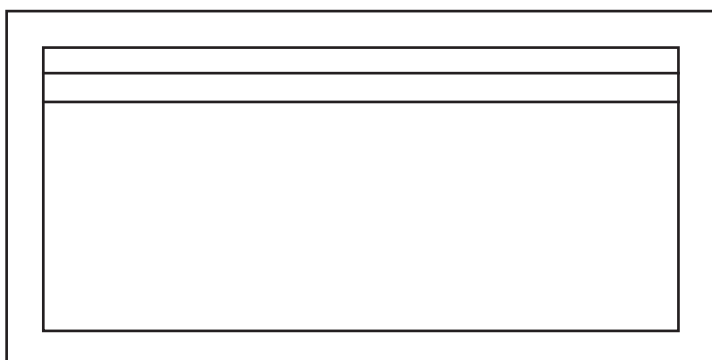

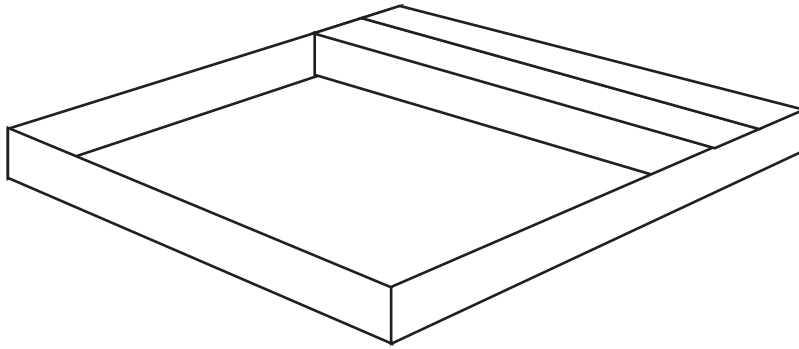

Display tray w/ ring holder with straight sides

Size: 30x21x3cm

Price: € 37.70

Block Charge:€ 43.00, Min Qty: 10

Display tray w/ ring holder with raised flat 2cm wide border (no padding under leather)

Size: 34x24x3cm

Price: € 38.30

Block Charge:£ 43.00, Min Qty: 10

Size: 30x15x2cm

Price: € 43.60

Block Charge:£ 43.00, Min Qty: 10

Size: 34x27x3cm

Price: € 60.55

Block Charge:£ 43.00, Min Qty: 10

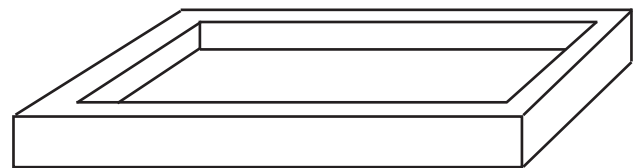
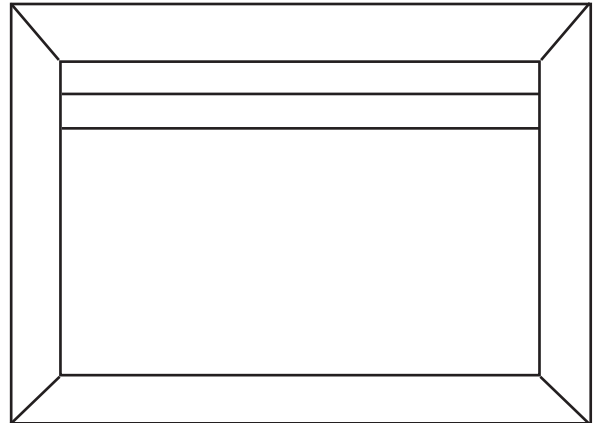

Side view

All boxes in this range are supplied with an embossed design all over which can incorporate your logo.
Please ask to see the designs available

Verona Jewellery box large

Size: 25x20x8cm, high split 2/6cm

Price: € 119.90

Price with Flap: € 122.75

Block Charge: Flap € 73.50

Block Charge: Lid € 73.50, Min Qty: 2

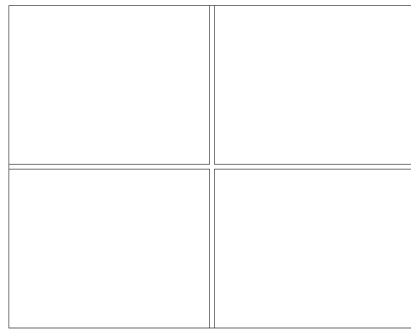
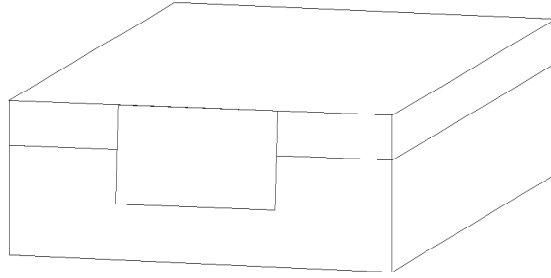

Inside base

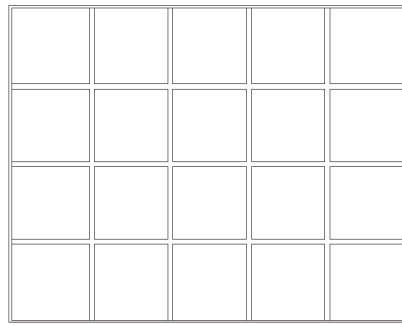

Tray A 20 compartments

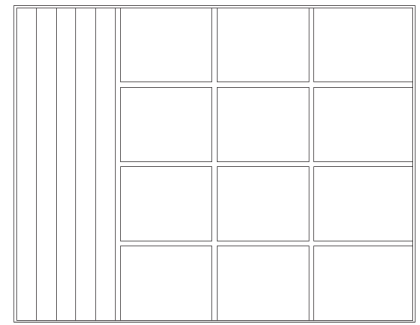

Tray B 12 compartments & 5 ring rolls

Verona Jewellery box medium

Size: 20x15x8cm, high split 2/6cm

Price: € 83.50

Price with Flap: € 86.35

Block Charge: Flap € 55.00

Block Charge: Lid € 55.00, Min Qty: 2

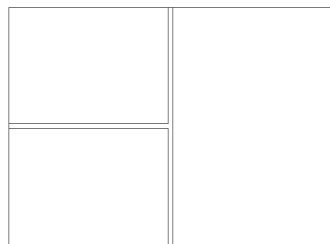
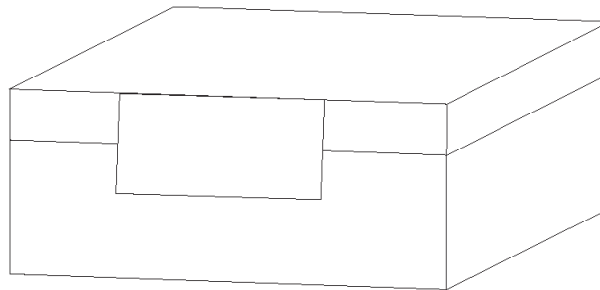

Inside base

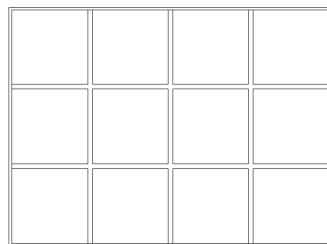

Tray A 12 compartments

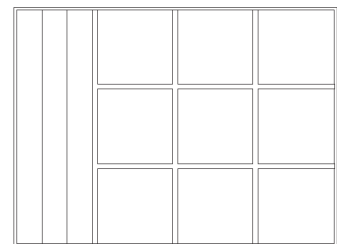

Tray B 9 compartments & 3 ring rolls

Lugano Jewellery box with tray

Size: 16x12.5x6cm, high split 2/4cm

Price: € 60.40

Block Charge: € 55.00, Min Qty: 2

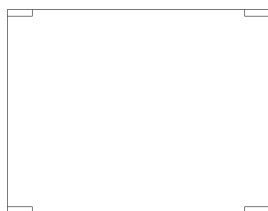
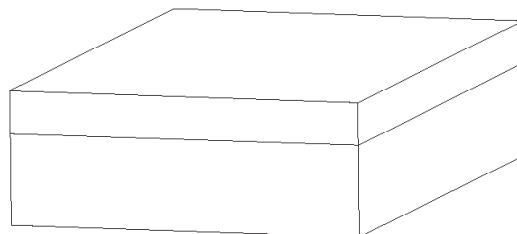

Inside base

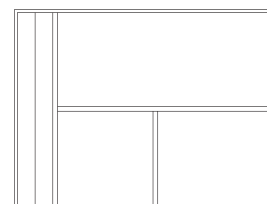

Tray A

Ravenna Jewellery box

Size: 19x14.5x3.5cm

Price: € 48.45

Block Charge: € 77.15, Min Qty: 2

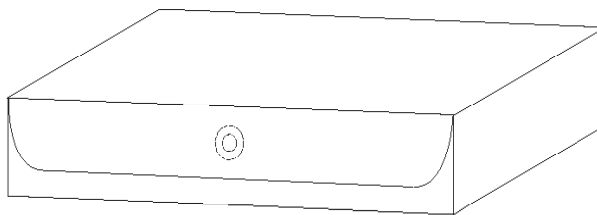
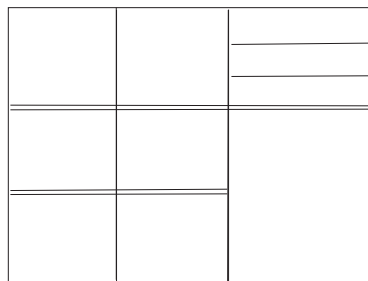

Ravenna Jewellery box small

Size: 14.5x9.5x3cm

Price: € 30.85

Block Charge: € 55.00, Min Qty: 5

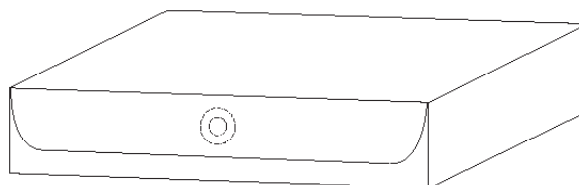
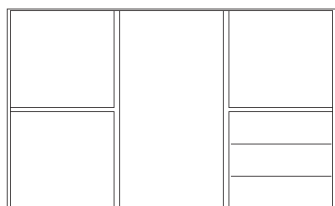

**Gentlemen's watch collectors box
6 compartments**

Size: 30x9.5x7.5cm

Price: € 73.60

Block Charge: € 77.15, Min Qty: 2

4 compartments

Size: 20.5x9.5x7.5cm

Price: € 55.20

Block Charge: € 77.15, Min Qty: 2

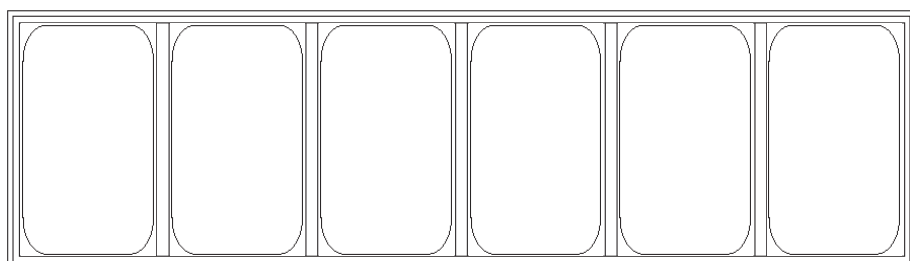

**Ladies watch collectors box
6 compartments**

Size: 30x8.5x6cm

Price: € 66.25

Block Charge: € 77.15, Min Qty: 2

4 compartments

Size: 20.5x8.5x6cm

Price: € 47.45

Block Charge: € 77.15, Min Qty: 2

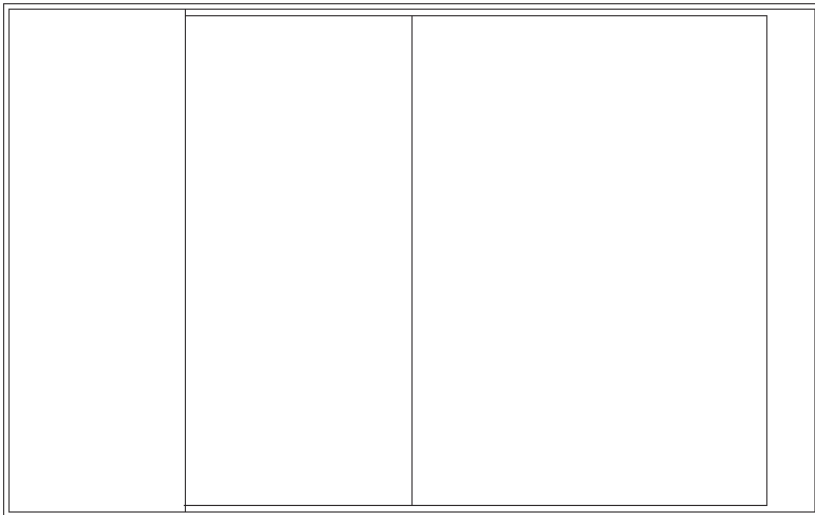
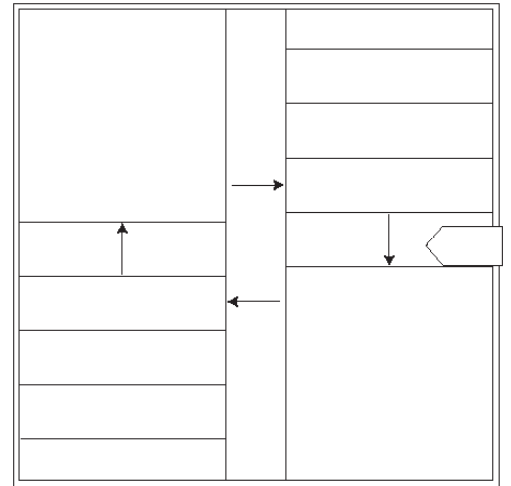

Photo album with 12 plastic pockets

Size: 13.5x17cm (closed)
 Price: € 18.60
 Block Charge: € 55.00, Min Qty: 10



2 way credit card wallet w/stud

Size: 8x16cm (closed)
 Price: € 18.36
 Block Charge: € 43.00, Min Qty: 10

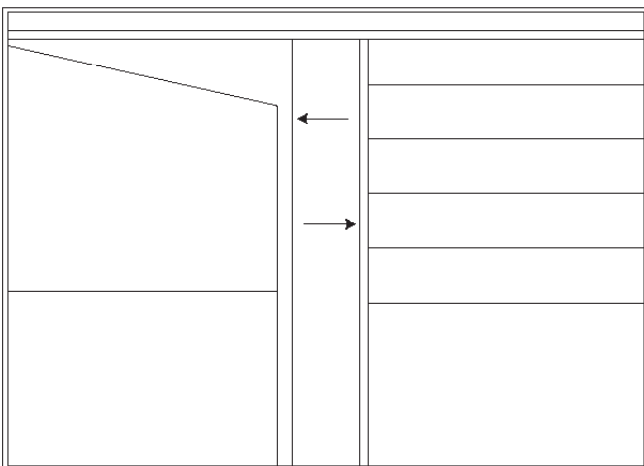

Passport C/C Wallet

Size: 10.5x15cm (closed)
 Price: € 26.28
 Block Charge: € 55.00, Min Qty: 10

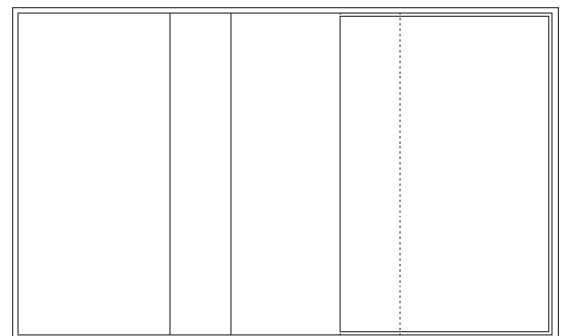

Business C/C Holder Folded with plastic pockets

Size: 9x11cm (closed)
 Price: € 16.74
 Block Charge: € 43.00, Min Qty: 10

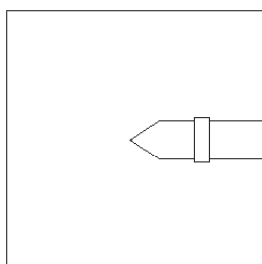

Post it note cover medium

Includes post it note pad
 Size: 8.5x8.5x1cm (closed)
 Price: € 7.65
 Block Charge: € 43.00 , Min Qty: 10

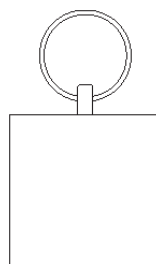

Key fob

Size: square / round = 5x5cm,
 rectangle / oval = 6x4cm
 Price: € 3.15 / Price oval: € 2.85
 Block Charge (per side): € 31.00 ,
 Min Qty: 25



Business card holder

Size: 10.5x6.5cm (2 pockets)
 Price: € 6.05
 Block Charge (per side): € 31.00,
 Min Qty: 25

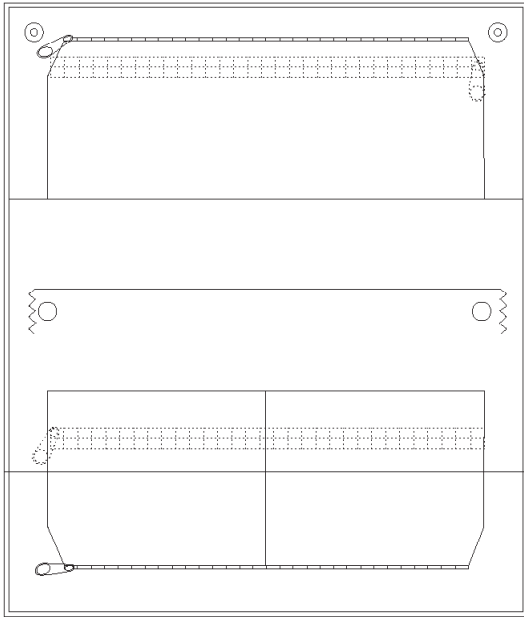

Jewellery roll large

Size: 23x10cm (closed)

Price: € 41.20

Block Charge: € 77.15, Min Qty: 5

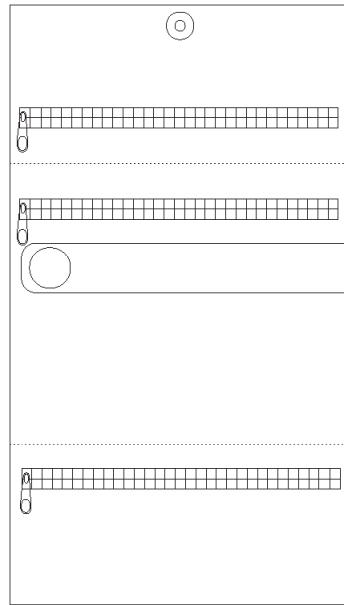

Jewellery roll Medium

Size: 30x14.5cm (open)

Price: € 32.50

Block Charge: € 55.00, Min Qty: 25

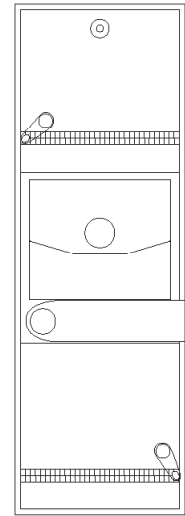

Jewellery roll small

Size: 24x7.5cm (open)

Price: € 19.55

Block Charge: € 43.00, Min Qty: 25

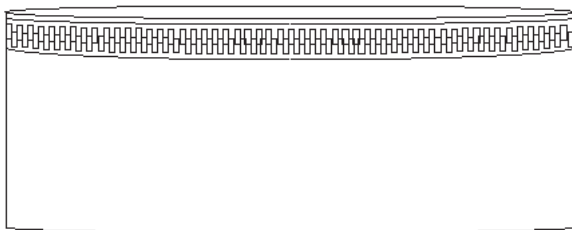

Oval jewellery box w/zip & tray

Size: 15x10x6cm

Price: € 41.70

Block Charge: € 55.00, Min Qty: 5

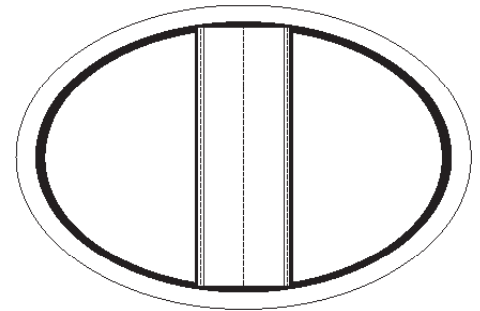

Tray for Oval jewellery box w/zip

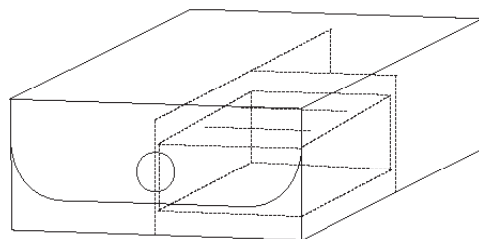

Size: 10x10x4cm (2 compartments with fixed ring holder)

Price: € 21.00

Block Charge: € 43.00

Min Qty: 10

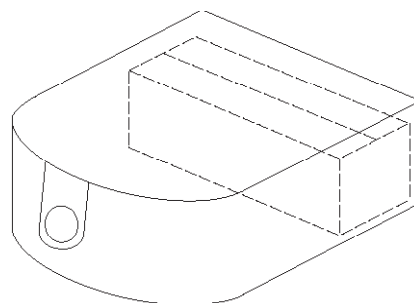

New horseshoe box

Size: 9.5x10x4cm

Price: € 19.85

Block Charge: € 43.00

Min Qty: 10

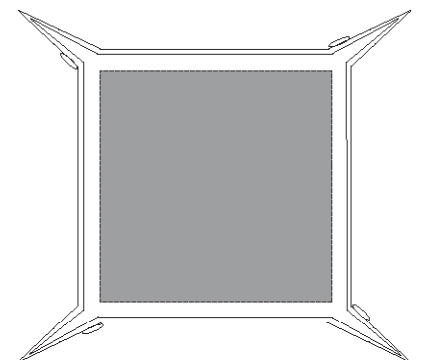

Jewellery tray small

Size: 10x10cm with 3cm (shaded area fabric or leather)

Price: Fabric € 16.30 / Leather € 22.85

Block Charge: Inside € 43.00 / outside € 55.00

Min Qty: 25